



DA-20

Ultrasonic Scaler

User Manual

CONTENT

Copyright & Declaration	3
1. Introduction	4
2. Installation	7
3. Operating instruction	12
4. Cleaning and sterilization	17
5. Troubleshooting	18
6. Storage, maintenance and transportation	20
7. Maintenance	20
8. After-sale service	21
9. Symbols description	21
10. Environmental Protection	23
11. Manufacturer's rights	24
12. Electromagnetic compatibility	25
13. Index: Table of tip power for use	30

Copyright & Declaration

Copyright URIT Medical Electronic Co., Ltd. All rights reserved.

This document is an English translation of the original Chinese version.

Congratulations on your purchase of DA-20 Ultrasonic Scaler from URIT Medical Electronic Co., Ltd. .It will bring you a new experience and convenience.

The manual is compiled in accordance with the relevant laws and regulations of China and the specific conditions of the DA-20 manufactured by URIT Medical Electronic Co., Ltd.

The manual includes the latest information as of the time of printing. URIT Medical Electronic Co., Ltd. is solely responsible for the revision and explanation of the simplified Chinese version of the manual, and reserves the right to change the relevant content after the manual is printed without prior notice. The pictures involved in this manual are schematic diagrams and are for reference only. If the pictures do not match the actual product, the actual product shall prevail.

All materials in this manual are protected by copyright law. Without the prior written consent of URIT Medical Electronic Co., Ltd., any form of reproduction, photocopying, or translation of any content in the manual is not allowed to be translated into other languages.

The operator must strictly follow this manual to operate. Otherwise, URIT Medical Electronic Co., Ltd. shall not be responsible for any errors and equipment failures caused by illegal operations.



NOTICE: URIT Medical Electronic Co., Ltd. does not promise that the device will be used for a certain special purpose and make any implied guarantee for its marketability and applicability.

If you need after-sales service support, please contact Guilin Veirun Medical Technology Co., Ltd. or an authorized agent.

1. Introduction

1.1. Overview

DA-20 adopts piezoceramic ultrasonic technology, which uses high-frequency and high-energy vibrations generated by ultrasonic waves to clean the surface of the teeth, break up calculus and stains in the periodontal pockets by tips, and then the rubble and plaque are washed down by the water spray produced by the device. It is designed for gingival, subgingival cleaning and root canal washing and has the function of automatic water supply. It has following characteristics:

- The irrigation system inside the product is made of anti-bacterial materials. The liquids used in clinics, such as hydrogen peroxide, chlorhexidine, sodium hypochlorite, etc., can be applied in the mode of automatic water supply system, which can significantly improve the performance of teeth cleaning and root canal washing.
- The handpiece can be sterilized at 135°C temperature and 0.22 MPa pressure.
- Automatically search for the best working condition, the performance of device is more stable.
- The device has a built-in computer microprocessing chip, which can intelligently control the working power and make treatment more comfortable.
- The wireless foot switch is used to remotely control the unit, which is more convenient to operate. At the same time, wired foot switches can also be selected according to user needs.
- High-brightness LED, which can improve the efficiency of clinical operation, and it can also use ordinary plug-in handpiece that has high compatibility.
- The product service life is 10 years.

1.2. Equipment description

The product is mainly composed of function control circuit, power supply circuit, irrigation system, tip, handpiece, and foot switch.

1.3. Intended use

The product is intended use for removing tartar, plaque on the surface of teeth and in periodontal pockets, cleaning and washing root canals.

1.4. Contraindications

- Patients with hemophilia is forbidden.
- Patients with heart pacemaker is forbidden.
- Doctors with heart pacemaker is forbidden.
- Use with caution in patients with heart disease, pregnant women and young children.

1.5. Technical parameters

- Input Voltage: 220 V \pm 22 V ~ , 50/60 Hz
- Input Power: 35 VA
- Batteries of wireless foot switch: AA Batteries \times 2
- Receiving sensitivity: -114 dB, receive frequency: 2.4 G-2.5 G
- Tip amplitude: minimum, 1 μ m, deviation -50%
maximum, 100 μ m, deviation +50%
- Half deflection force: minimum, 0.1 N, deviation -50%
maximum, 5 N, deviation +50%
- Vibration frequency of tip: 18 kHz ~ 45 kHz

Note: The vibration frequencies of different types tips are different, but they are all distributed within the described range.

- Output Voltage of tip: 3 W ~ 20 W
- Fuse: T1AH250V
- Weight: 1.8 kg
- Operation modes: continuous running

- Protection against electric shock rating: Class II equipment
- Protection against electric shock degree: B-type application part
- Ingress protection rating : Ordinary equipment (IPX0), Wired foot switch is waterproof equipment (IPX1) , Wireless foot switch is waterproof equipment (IPX4)
- Degree of safety application in the presence of a flammable anesthetic mixture with air, oxygen, or nitrous oxide:Non-AP,APG type equipment
- Wireless foot switch:
 - Emission frequency: 2.412 GHz–2.462 GHz
 - Modulation type: GFSK
 - Effective radiated power: 12 dbm

1.6. Operation environment

- a) Ambient temperature: 5 °C~ 40 °C
- b) Relative humidity: ≤80%
- c) Atmospheric pressure: 70 kPa~106 kPa
- d) Applicable range of power supply voltage : 220 V ± 22 V ~

1.7. Side effects, adverse events and measures

According to the results of many years of clinical treatment with similar equipment, there are no serious side effects except that the enamel of the treatment site may leave a few scratches that can be recovered.

If any unexpected action occurs during the use of this device, please immediately power off it to stop the device to ensure safety. When using the device, pay attention that the tip needs enough water to dissipate heat, otherwise may burn the patients. If burns occur, please stop using the device immediately and perform corresponding diagnosis and treatment according to the burns.

2. Installation

2.1. Front/Back view

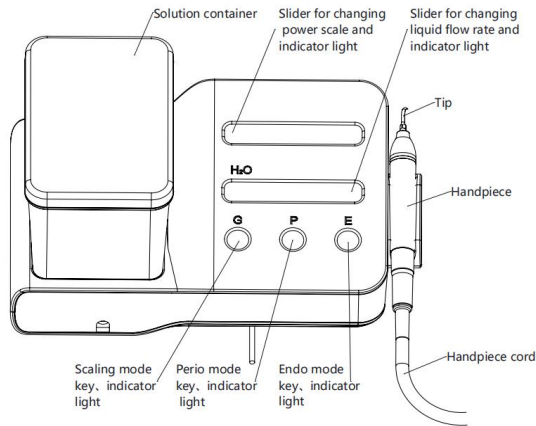

Figure 2.1

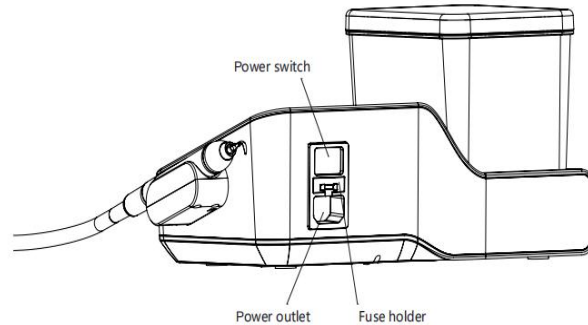

Figure 2.2

Figure 2.1 :

Solution container: Storage solution for scaling.

Slider for changing power scale and indicator light : it used for changing power scale and displays the power scale of the current working state.

Slider for changing liquid flow rate and indicator light : it used for changing liquid flow rate at the tip and displays the flow rate of the current working state.

Tip: used in conjunction with ultrasonic scaler for cleaning and reshaping the surface of teeth, root canals and other parts

Handpiece: used in conjunction with scaler with water spray function

Handpiece cord: used to connect hanpieceee and unit

Endo mode key, indicator light : switching the endo mode, the light is on to indicate that the ultrasonic scaler is in endo state.

Perio mode key, indicator light : switching the perio mode, the light is on to indicate that the ultrasonic scaler is in perio state.

Scaling mode key, indicator light: switching the scaling mode, the light is on to indicate that the ultrasonic scaler is in Scaling state.

Figure 2.2:

Power switch: switching the power state

Power outlet: power input

Fuse holder: place the fuse

2.2. Connection of the accessories

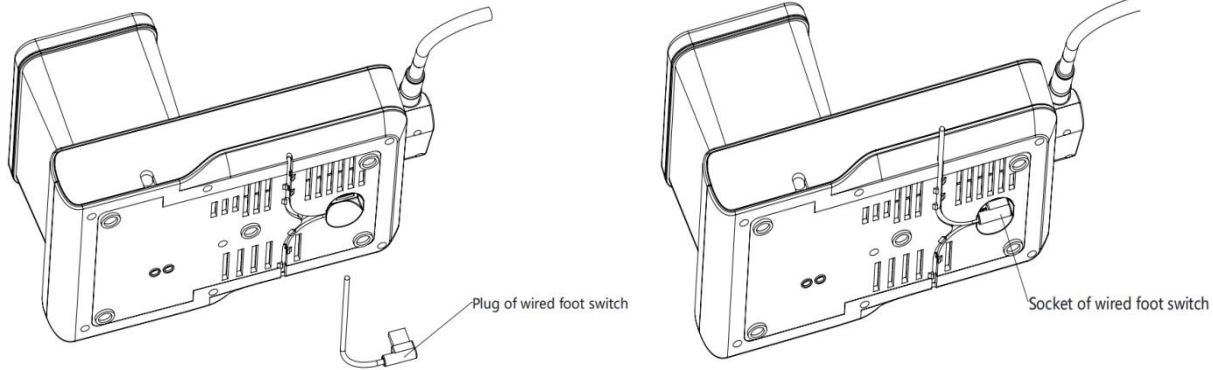

Figure 2.3

Socket of wired foot switch is at the bottom of the device, it will be inserted into the forward or backward of the wire groove firstly according to the user's needs.

2.3. Solution container installation

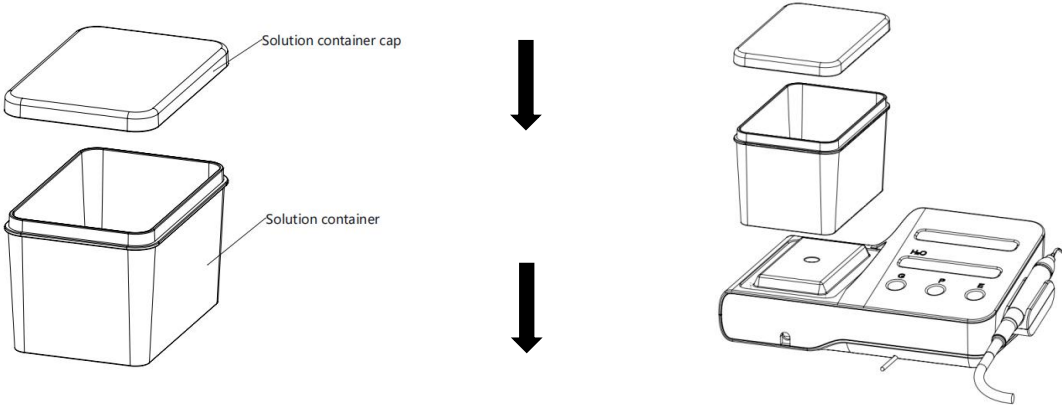

Figure 2.4

2.4. Handpiece installation

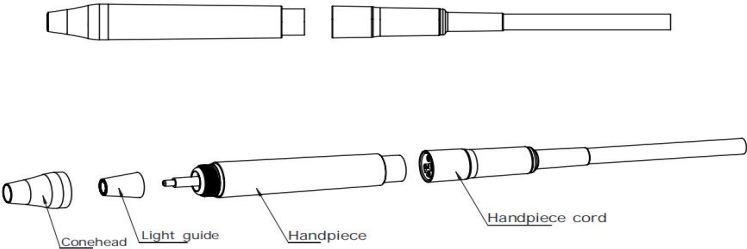

Figure 2.5

2.5. Tip installation

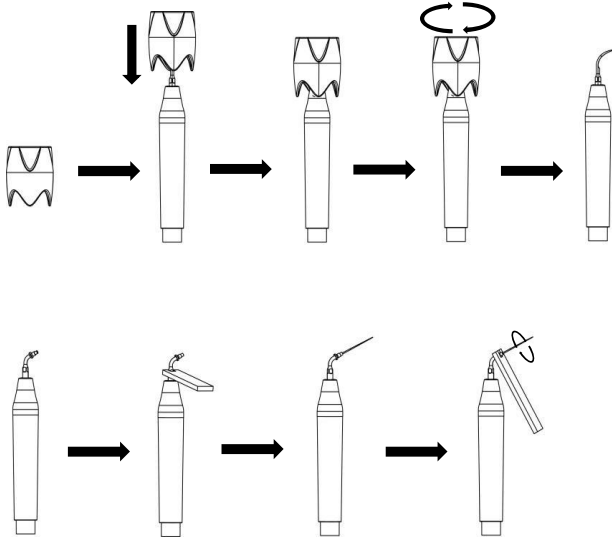

Figure 2.6

2.6. Matching code for wireless foot switch

- 1) Press and hold the three keys "G", "P" and "E" at the same time until the indicator light of liquid slider starts to flash slowly under the device is power on.
- 2) Keep foot switch pressed and insert two AA batteries (operate when indicator light of liquid slider starts to flash slowly at the same time) ,and then foot switch will enter matching mode and it should keep pressed state for 3 seconds after it is power on.
- 3) Loosen foot switch and restart, and the device can be controlled by wireless foot switch.
- 4) Press and hold the three keys "G", "P" and "E" at the same time when these three modes are at 10 scales , and the device will cancel all match.
- 5) Press and hold the three keys "G", "P" and "E" at the same time when the liquid flow rate is 10 scales, the device will enter the calibration mode of liquid flow rate. Don' t enter this mode under normal circumstances. If necessary, please contact the dealer or contact the manufacturer.

Note:Tear off the membrane behind the sticker and stick it on the bottom of foot switch for waterproofing

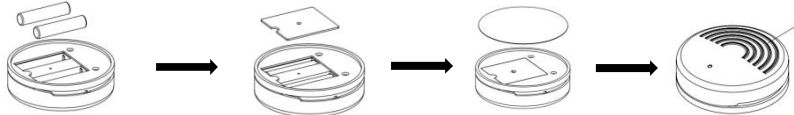

Figure 2.7

Press "1" to start the device.

3. Operating instruction

3.1. Major components of handpiece

Conehead: it can be unscrewed, users can take out the conehead regularly and clean the main pole with alcohol.

Light guide: it can be cleaned with alcohol.

Handpiece: it is the important parts of the device, which can be at high temperature and high pressure environment.

Handpiece cord: it is used for connecting the handpiece and irrigation system and circuit of the unit .



NOTICE: Please keep the handpiece and socket dry.

3.2. Torque wrench

- 1) The design of torque wrench adopts a special structure, which can ensure the user can effectively load and unload the tip and protect the user's hand during use, and it can avoid be scratched by the tip when load and unload the tip(See Figure 2.6).
- 2) Put the tip into the wrench and hold the handpiece tightly, rotate the tip in a clockwise direction till the tip does not turnround anymore, and then it is installed.
- 3) Unload the tip: Hold the handpiece and rotate the tip in a counter-clockwise direction by wrench to remove it.
- 4) Once after using, please put the wrench into sterilization cabinet to sterilize.
- 5) After sterilization, due to the high surface temperature of the torque wrench, the wrench needs to be cooled before it can be used again to avoid burns.
- 6) When the torque wrench is not in use, place it in a ventilated and dry place and keep it clean.

3.3. Scaling function for gingiva and subgingival

- 1) Open the package and check whether the accessories of the product are complete according to the packing list. Take out the device from the box and place it on a stable surface facing the operator.
- 2) Set the slider for changing liquid flow rate to the max scale.

- 3) Insert the battery into the wireless foot switch or insert the plug of the wired foot switch into the foot switch socket(See Figure 2.3 and Figure 2.7).
- 4) Open the solution container cap, put a proper amount of pure water into container, close the cap, and install the container to the installation position of container on the device(Figure 2.4).
- 5) Fasten the tip to the handpiece with torque wrench (See Figure 2.6), and then correctly connect the handpiece with the handpiece cord socket. Before installing the handpiece, dry the connection end of the handpiece and the socket thoroughly(Figure 2.5).
- 6) Power off the device, then connect the output of the power cord to the device, and then connect the input of the power cord to the electric supply(See Figure 2.2).
- 7) Power on the device, and the “G” indicator light and the first 3 power indicator lights will light up at this time.
- 8) The operator selects the "G" and "P" modes according to the series of the tips, and the power of the tip is shown in the attached table.
- 9) The frequency is relatively fast when the product is working normally, ensure that the device has normal water output, only light touch and reciprocating movement at a certain speed can be used to eliminate dental calculus, and there is no obvious feeling of heating at the tip; Excessive local force or staying for too long when cleaning teeth.
- 10) Vibration intensity: adjust the vibration intensity according to your needs. Generally, user can adjust it to a medium vibration intensity. User can also adjust the vibration intensity at any time during the clinical process according to the patient's sensitivity and the hardness of the calculus.
- 11) Liquid flow rate: step on the foot switch, the tip will vibrate, slide the liquid slider to make the liquid into a semi-atomized state to cool the tip and clean the teeth.
- 12) Generally use the pen position to hold the handpiece.
- 13) During scaling, do not make the tip be in vertical contact with the teeth, and do not apply heavy pressure to avoid damage to the teeth and tip.

- 14) After completing scaling, keep working for 30 seconds under the water supply to clean the handpiece and tip.
- 15) Remove the tip and then pull out the handpiece for sterilization.



NOTICE:

- 1) Please do not pull out the handpiece when stepping on the foot switch and the tip vibrates.**
- 2) If do not use the wireless foot switch for a long time, please remove the battery.**
- 3) Please do not move or turn over the device when it is working.**

3.4. Endo function

- 1) Fix the holder of endo file to the handpiece with endo wrench (See Figure 2.6).
- 2) Unscrew the nut of the holder .
- 3) Insert the endo file into the hole in front of the holder.
- 4) Tighten the nut of the endo file with endo wrench.
- 5) Press "E", the "E" indicator lights up.
- 6) When the Endo function is selected, slowly extend the endo file into the patient's root canal, step on the foot switch and start the root canal washing. Adjust the power of root canal washing as needed.



NOTICE:

- 1) Tighten the endo tip.**
- 2) Tighten the nut of the holder.**
- 3) Do not apply heavy pressure when root canal washing.**
- 4) Do not step on the foot switch when the endo file is not placed in the root canal.**
- 5) It is recommended that the power adjustment start from the 1st scale and slowly increase to the 3rd scale when using the Endo function.**

6) Please do not move or turn over the device when it is working.

3.5. Wireless foot switch

3.5.1. Operating

- 1) Put 2 AA batteries into the wireless foot switch in the direction indicated by the positive and negative poles, install the battery cover and glue the waterproof rubber pad, and tighten the cover screws.
- 2) Place the wireless foot switch flat on the ground.
- 3) After matching with ultrasonic scaler, power on the device and then user can use the wireless foot switch to control the device.
- 4) Within 5 meters of the ultrasonic scaler, the vibration of the device can be controlled by the wireless foot switch at any position. Please be careful not to have large obstacles between the foot switch and the device, so as not to affect the wireless transmission.

3.6. Automatic water supply

3.6.1. Operating:

- 1) Pull out the container installed on the device vertically upwards.
- 2) Open the cap of container, add enough pure water, and then close the cap tightly.
- 3) Clean bottleneck and socket connection of container.
- 4) Insert the container vertically into the container interface of automatic water supply on the device.



NOTICE:

- 1) **Make sure that the air vent and water outlet are not blocked.**
- 2) **Check if the gasket in the cap is fine. If the gasket is deformed or falls off, please replace and install it in time.**
- 3) **Please clean the connection of the container before each use.**
- 4) **Please add liquid in time to keep the liquid path unblocked when the liquid in the container is**

lower than the lower limit.

3.7. Precautions

- 1) Keep the device clean and dry before or after use.
- 2) Prohibit suspended or inverted device.
- 3) Before each use, please let the device work for 30 seconds under the condition of water to remove the residual water in the pipeline.
- 4) The operator should be equipped with adequate protection (such as goggles, mask, etc.) to prevent cross-infection.
- 5) Using the product must comply with the requirements of the relevant operating specifications and relevant laws and regulations of the medical department, and it is limited to trained doctors or technicians.
- 6) Before each use, please sterilize the tip, wrench and other accessories.
- 7) Don't tighten or loosen the tips when the handpiece is activated.
- 8) Tighten the tips.
- 9) When the tip is damaged or worn, the vibration intensity will decrease. The operator should replace the tip with a new one according to the clinical situation.
- 10) Don't bend or sharpen the tips.
- 11) Don't use unclean water, and do not use normal saline instead of pure water sources.
- 12) Don't pull the tail wire forcefully during the use to avoid damage to the tail wire.
- 13) Don't beat and scrape the handpiece in a hurry.
- 14) After using the device, power off the device and pull out the power plug.
- 15) Our company specializes in producing medical devices and we're responsible for its security only when the device maintained, repaired and modified by URIT or Distributor authorized by the our Company, and the replacement accessories are made by our Company and operating follow the user manual.
- 16) The internal thread of the tips produced by some manufacturers is rough, rusty, chipped or adopts other

standard threads. When used with the handpiece, it is easy to damage and slip the teeth, and even cause irreparable damage to the product. Please use the original tip.

- 17) When the operator uses a different series of tips, it needs to adjust the working mode accordingly to avoid breaking the tip.
- 18) Don't move or flip the device during use.

4. Cleaning and sterilization

4.1. Handpiece

4.1.1. When using alcohol for sterilization, use 70%~80% (volume ratio) ethanol to soak a piece of clean dry gauze, and then use this gauze to wipe the surface to be sterilized twice for 3 minutes. Dry or wipe the residual alcohol with a clean, dry cloth.

4.1.2. Sterilization

- 1) Please sterilize at 135°C temperature and 0.22MPa for 15 minutes by high pressure sterilizer.
- 2) Pull out the handpiece and remove the tip after each use.
- 3) Wrap the handpiece with a disinfectant towel or bag.
- 4) After sterilization, the handpiece should be naturally cooled before use again to avoid scalding.



NOTICE:

- 1) **Before sterilization, use compressed air to remove the cleaning fluid remaining in the handpiece.**
- 2) **When sterilization, ensure to remove the tip from the handpiece, and avoid mixing it with other instruments for sterilization.**
- 3) **When sterilization, please always pay attention to whether the handpiece is damaged externally. It is strictly forbidden to apply any protective oil on the surface of the handpiece.**
- 4) **Sterilizable parts can be sterilized at least 250 times**
- 5) **It is strictly forbidden to sterilize the handpiece in the following ways:**
 - **Put the handpiece in the solution and cook.**

- Soak the handpiece with disinfectant water such as iodine, alcohol, glutaraldehyde, etc.
- Put it into the oven or microwave oven to bake at high temperature.

4.2. Tip

The tips can be sterilized in high temperature and pressure environment.

4.3. Torque wrench and Endo wrench

- 1) Torque wrench and Endo wrench can be sterilized in high temperature and pressure environment.
- 2) It is strictly forbidden to sterilize in the following ways:
 - Put it in the solution and cook.
 - Soak it with disinfectant water such as iodine, alcohol, glutaraldehyde, etc.
 - Put it into the oven or microwave oven to bake at high temperature.



NOTICE:

We will not be responsible for the damage to the torque wrench and endo wrench directly or indirectly caused by the improper use of the above methods.

4.4. Cleaning Tips, Torque wrench and Endo wrench

Tips, Torque wrench and Endo wrench can be cleaned by the ultrasonic cleaning machine.

5. Troubleshooting

Error	Possible causes	Solutions
Turn on the power switch, there is no indicator light on the panel	Poor contact of power plug	Plug in the power plug tightly
	Internal fuse not working	Contact your local dealer or our company
There is no vibration or no water spray at the tip after stepping on foot switch	Poor contact of wired foot switch	Plug in the plug of foot switch tightly
	Batteries are out of power of wireless foot switch	Change new batteries
	Foot switch not working	Match the foot switch again (please refer to paragraph 2.6)

After stepping on the foot switch, the tip does not vibrate but there is water spray at the tip	Tip loose	Fasten the tip using the wrench
	Faulty handpiece	Pull out handpiece and contact your local dealer or our company
	Faulty handpiece cord or inside circuit	Contact your local dealer or our company
There is water spray at the tip after power off	Faulty electromagnetic valve	Contact your local dealer or our company
Handpiece overheating	Spray is set up too small	Adjust the spray
Handpiece overheating seriously	Faulty handpiece	Pull out handpiece and contact your local dealer or our company
Inadequate amount of spray	Spray is set up too small	Adjust the spray
	The water circuit is blocked	Unblock the water circuit by three-ways syringe
Weak tip vibration	Tip loose	Fasten the tip using the wrench
	There is not dry between the base of the handpiece and its cord	Dry the connector between the base of the handpiece and its cord by hot air
	Worn or bent tip	Replace the tip
Water is leaking between the base of the handpiece and its cord	Wear of the seal	Replace the seal
There is no vibration or noisy at root canal file	Loose clamping nut	Tighten clamping nut
	Damaged root canal holder	Replace root canal holder



NOTICE: If the fault still cannot be resolved, please contact your local dealer or our company.

6. Storage, maintenance and transportation

6.1. Storage and maintenance

- The device should be handled with care, far away from the earthquake source, and should be installed or stored in a cool, dry and ventilated place.
- Do not mix with toxic, corrosive, flammable and explosive materials during storage.
- When the product is not used for a long time, it should be connected to water and electricity once a month, each time for 5 minutes.
- Store temperature from $-20\text{ }^{\circ}\text{C}$ to $55\text{ }^{\circ}\text{C}$, relative humidity $\leq 95\%$, atmospheric pressure from 70 kPa to 106 kPa.

6.2. Transportation

- Transport should not be mixed with dangerous goods.
- Avoid excessive shock and vibration during transportation, handle with care and avoid upside-down.
- Keep away from rain, sunlight or snow during transportation.

7. Maintenance

Maintenance list as follow:

No.	Name	Specification/model
1	Main board	/
2	Touch keyboard	/
3	Handpiece	/
4	Handpiece cord	/
5	Tips	/
6	Torque wrench	/
7	Endo wrench	/







8	Endo tips	/
9	Liquid pipe	4mm × 6mm
10	Power cord	/
11	Electromagnetic valve	/
12	Wireless foot switch	/
13	Wired foot switch	/















NOTICE: The manual does not exhaustively list the accessories and specifications of the DA-20. Please refer to the random delivery materials and packing list for details.





8. After-sale service

This device is guaranteed by the warranty card from the date of sale, and is responsible for lifetime maintenance. Irreparable device damage caused by non-designated dedicated maintenance personnel is not covered by the free warranty.

9. Symbols description

Symbol	Description	Symbol	Description
	Trademark		Fuse
	Caution		AA batteries
	Refer to instruction manual/ booklet		Manufacturer

Symbol	Description	Symbol	Description
	“ON” (power)		“OFF” (power)
	This symbol indicates that the waste of electrical and electronic equipment must not be disposed as unsorted municipal waste and must be collected separately. Please contact an authorized representative of the manufacturer for information concerning the decommissioning of your equipment.		
	Date of manufacture		Use by date
	Temperature Limit		Atmospheric pressure limitation
	Humidity limitation		Serial number
	This way up		Fragile, handle with care
	Keep away from rain		CLASS II equipment
	Type B applied part: The applied part is not conductive to the patient		Medical device

Symbol	Description	Symbol	Description
	Sterilisation at 135°C in an autoclave		Connection of the foot switch
Liquid	Slider for changing liquid flow rate	Power	Slider for changing power scale
	Slider regulation direction	IPX1 IPX4	Ingress protection rating
	Do not roll		Stacking limit by number

10. Environmental Protection

Name	Toxic and harmful substances or elements					
	Pb	Hg	Cd	Cr (VI)	PBB	PBDE
Handpiece component	O	O	O	O	O	O
Valve component	O	O	O	O	O	O
Plastic shell	O	O	O	O	O	O
Liquid pipe and joint	O	O	O	O	O	O
Circuit board	O	O	O	O	O	O

Name	Toxic and harmful substances or elements					
	Pb	Hg	Cd	Cr (VI)	PBB	PBDE
Stamping parts	O	O	O	X	O	O
Switch	O	O	O	O	O	O
Cord	O	O	O	O	O	O
Tips	O	O	O	O	O	O
Foot switch	O	O	O	O	O	O

The table is compiled in accordance with the provisions of SJ/T 11364.

O: It means that the content of this toxic and hazardous substance in all homogeneous materials of this part is below the limit requirement of GB/T 26572.

X: It means that the content of the toxic and hazardous substance in at least one of the homogeneous materials of the part exceeds the limit requirement of GB/T 26572.

(This product complies with the requirements of EU RoHS environmental protection: currently there is no mature technology in the world that can replace or reduce the lead content in electronic ceramics, optical glass, steel and copper alloys)

In accordance with *Administrative Measures on the Restriction of the Use of Hazardous Substances in Electrical and Electronic Products*, *Regulations on the Management of the Recycling and Disposal of Waste Electrical and Electronic Products* and related standards, please observe the safety and use precautions of the product, and recycling or disposal of this product please apply appropriate measures in accordance with local laws and regulations after the product is used.

11. Manufacturer's rights

The company reserves the right to modify the design, technology, accessories, user manual content and packing list content of the product at any time without notice. In case of discrepancies, the actual product shall prevail.

12. Electromagnetic compatibility



NOTICE:

1) Without the express consent of URIT, unauthorized changes or modifications to the device may cause electromagnetic compatibility(EMC) problems of the device or other device.

2) The design and test of device comply with the operating regulations related to EMC.

3) **WARNING:** Even if other devices meet the launch requirements of the corresponding national standards,the device or system may interfere with other electronic devices.

12.1. Cable length

Cable name	Type	Length
Power cord	Unshielded parallel line	1.8 m
Input line of foot switch	Unshielded parallel line	2.5 m
Handpiece cord	Unshielded parallel line	2 m

12.2. Key components of EMC

The product key components of EMC are the scaler's main board chip, touch board chip, transformer and diaphragm pump. The use or replacement of accessories, cables, transducers, etc. that are not designed to match will cause the electromagnetic emissions and immunity performance to be significantly reduced.Do not replace device parts without authorization.

12.3. Electromagnetic emissions

GUIDANCE AND MANUFACTURER' S DECLARATION- ELECTROMAGNETIC EMISSIONS		
DA-20 is designed for use in the electromagnetic environment described in the table below. The user or purchaser must ensure that the medical device is used in the environment described below.		
Emissions Test	Compliance	Electromagnetic environment – guidance
RF emissions GB 4824	Group 1	DA-20 uses radiofrequency energy for its internal operation. Consequently, its radiofrequency emissions are very low and are not likely to create any interference with other nearby equipment. DA-20 is suitable for use in all establishments, including domestic and those directly connected to the low voltage energy supply public network supplying buildings used for domestic purposes.
RF emissions GB 4824	Class B	
Harmonic emissions GB 17625.1	N/A	
Voltage fluctuation and flickers GB 17625.2	Conforming	

12.4. Electromagnetic immunity

GUIDANCE AND MANUFACTURER' S DECLARATION- ELECTROMAGNETIC IMMUNITY			
DA-20 is designed for use in the electromagnetic environment described in the table below. The user or purchaser must ensure that the medical device is used in the environment described below.			
Immunity test	IEC 60601 test level	Conformity level	Electromagnetic environment – guidance
Electrostatic discharge (ESD) GB/T 17626.2	± 6 kV contact	± 6 kV contact	Floors should be wood, concrete or ceramic tile. If floors are covered with synthetic material, relative humidity should be at least 30%.
	± 8 kV air	± 8 kV air	
Electrical fast transient/burst GB/T 17626.4	± 2 kV for power supply lines ± 1 kV for input/output lines	± 2 kV for power supply lines ± 1 kV for link cable	Main power quality should be that of a typical commercial or hospital environment.

Surge GB/T 17626.5	± 1 kV differential mode ± 2 kV common mode	± 1 kV differential mode	Main power quality should be that of a typical commercial or hospital environment.
Voltage dips, short interruptions and voltage variations on power supply input lines. GB/T 17626.11	< 5%U _T (>95% dip in U _T) for 0.5 Cycle 40%U _T (60% dip in U _T) for 5 Cycles 70%U _T (30% dip in U _T) for 25 Cycles < 5%U _T (>95% dip in U _T) for 5 seconds	< 5%U _T (>95% dip in U _T) for 0.5 Cycle 40%U _T (60% dip in U _T) for 5 Cycles 70%U _T (30% dip in U _T) for 25 Cycles < 5%U _T (>95% dip in U _T) for 5 seconds	Main power quality should be that of a typical commercial or hospital environment. If the user of DA-20 requires continued operation during power main interruptions, it is recommended that the DA-20 be powered from an UPS or battery supply.
Power frequency (50–60 Hz) magnetic field GB/T 17626.8	3 A/m	3 A/m	Power frequency magnetic fields should be at levels characteristic of a typical location in a typical commercial or hospital environment.
NOTE:U _T is the A.C. mains voltage prior to applications of the test level.			

12.5. Electromagnetic immunity

GUIDANCE AND MANUFACTURER'S DECLARATION- ELECTROMAGNETIC IMMUNITY			
DA-20 is designed for use in the electromagnetic environment described in the table below. The user or purchaser must ensure that the medical device is used in the environment described below.			
Immunity test	IEC 60601 test level	Conformity level	Electromagnetic environment – guidance

Conducted RF	3 Vrms	3 Vrms	<p>Portable and mobile RF communications equipment should be used no closer to any part of DA-20, including cables, than the recommended separation distance calculated from the equation applicable to the frequency of the transmitter.</p> <p>Recommended separation distance</p> $d = \left[\frac{3.5}{V1} \right] \sqrt{P}$ $d = \left[\frac{3.5}{E1} \right] \sqrt{P} \text{ } 80\text{MHz} \sim 80\text{MHz}$ $d = \left[\frac{7}{E1} \right] \sqrt{P} \text{ } 800\text{MHz} \sim 2.5\text{GHz}$ <p>Where P is the maximum output power rating of the transmitter in watts (W) according to the transmitter manufacturer and d is the recommended separation distance in meters (m). Field strengths from fixed RF transmitters, as determined by an electromagnetic site survey,^a should be less than the compliance level in each frequency range.^b</p> 
GB/T 17626.6	150 kHz ~ 80 MHz	3 V/m	
Radiated RF	3 V/m		
GB/T 17626.3	80 MHz ~ 2.5 GHz		
<p>NOTE 1 – At 80 MHz and 800 MHz, the higher frequency range applies.</p> <p>NOTE 2– These guidelines may not apply in all situations. Electromagnetic propagation is affected by absorption and reflection from structures, objects, and people.</p> <p>a. Field strengths from fixed transmitters, such as base stations for radio (cellular/cordless) telephone and land mobile radios, amateur radio, AM and FM radio broadcast and TV broadcast cannot be predicted theoretically with accuracy. To assess the electromagnetic environment due to fixed RF transmitters, an electromagnetic site survey should be considered. If the measured field strength in the location in which the DA-20 is used exceeds the applicable RF compliance level above, DA-20 should be observed to verify normal operation. If abnormal performance is observed, additional measures may be necessary, such as reorienting or relocating DA-20.</p> <p>Over the frequency range 150 kHz to 80 MHz, field strengths should be less than 3 V/m.</p>			

12.6. RECOMMENDED SEPARATION DISTANCES BETWEEN PORTABLE AND MOBILE RF

COMMUNICATIONS EQUIPMENT AND DA-20

RECOMMENDED SEPARATION DISTANCES BETWEEN PORTABLE AND MOBILE RF COMMUNICATIONS EQUIPMENT AND DA-20			
DA-20 is intended for use in an electromagnetic environment in which radiated RF disturbances are controlled. The customer or the user of DA-20 can help prevent electromagnetic interferences by maintaining a minimum distance between portable and mobile RF communications equipment (transmitters) and DA-20 as recommended below, according to the maximum output power of the communications equipment.			
Rated maximum output power of transmitter W	Separation distance according to frequency of transmitter M		
	150 kHz ~ 80 MHz	80 MHz ~ 800 MHz	800 MHz ~ 2.5 GHz
	$d = \left[\frac{3.5}{V1} \right] \sqrt{p}$	$d = \left[\frac{3.5}{E1} \right] \sqrt{p}$	$d = \left[\frac{7}{E1} \right] \sqrt{p}$
0.01	0.12	0.12	0.23
0.1	0.38	0.38	0.73
1	1.2	1.2	2.3
10	3.8	3.8	7.3
100	12	12	23
For transmitters rated at a maximum output power not listed above, the recommended separation distance d in meters (m) can be estimated using the equation applicable to the frequency of the transmitter, where P is the maximum output power rating of the transmitter in watts (W) according to the transmitter manufacturer. NOTE 1 – At 80 MHz and 800 MHz, the higher frequency range applies. NOTE 2 – These guidelines may not apply in all situations. Electromagnetic propagation is affected by absorption and reflection from structures, objects, and people.			

DA-20 has passed test according to the standard YY 0505-2012 and standard IEC 60601-1-2: 2004, but it cannot guarantee in any way that it is not affected by electromagnetic interference. DA-20 should be avoided using in high electromagnetic environments.

13. Index: Table of tip power for use

Model	Gear	Irrigation flow	Treatment type
G1	1-10(G)	YES	Supragingivale scaling
G2	1-10(G)	YES	Supragingivale scaling
G4	1-6(G)	YES	Supragingivale scaling
P1	1-10(P)	YES	Subgingival scaling
P3	1-10(P)	YES	Subgingival scaling
E1	1-3(E)	YES	Root canal washing
E3D	1-3(E)	YES	Root canal washing
E14	1-3(E)	YES	Root canal washing